

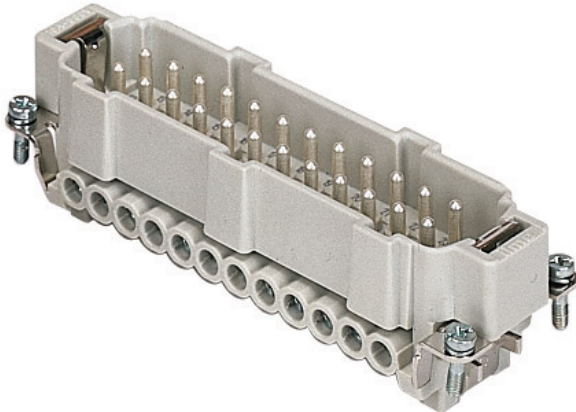

Part number



# CNEM 24 TN



## Brief description:

male insert, 24 poles + PE, No. 25 - 48, screw terminal connections, 16A, 500V, 6kV, 3, silver plated, size "104.62", CLASS insert series

Product description	
Model	male insert
Version	screw terminal connections
Series	CNE
Product type	with male contacts
Variant	with plate
Family	CLASS inserts
Size	size "104.62"
N. of poles	48 poles +  (2 inserts)
Technical data	
Current	16 A (A.C. and D.C.)
Voltage	500 V
Rated impulse withstand voltage	6kV
Pollution degree	3
Wire cross-section	0,50 mm <sup>2</sup> - 4,00 mm <sup>2</sup>
AWG size	20 - 12
Operating temperature range (min, max)	-50°C ... +70°C
Contact type	silver plated
Mating cycles	≥ 200
IP degree of protection	IP20 without enclosure, IP65/IP66 with enclosure
PE terminal stripping length	7 mm
PE wire cross-section	0,14 - 4 mm <sup>2</sup> ; AWG 20 - 12
Further technical details	
Characteristics according to EN 61984	16A 500V 6kV 3; 16A 400/690V 6kV 2
Insulation resistance	≥ 1 GΩ
Rated voltage according to UL/CSA	600V
UL 94 flammability rating	V-0
Weight	125,00 g

Approvals / Standards	
Reference standard	EN 61984 (2001-11)
Quality mark	   EAC
Conformity	CQC, CE
General ordering information	
EAN13 code	8015747033336
Tariff number	85369095
Country of origin	Made in EU (IT)
ETIM classification	EC000438
Packaging Information	
Packaging length	270,00 mm
Packaging height	75,00 mm
Packaging width	180,00 mm
Packaging weight	3,75 kg
Packaging volume	3,65 dm <sup>3</sup>
Packaging description	Carton box
Packaging quantity	30 Pcs
Packaging EAN code	8015747033343
Sub-packaging length	113,00 mm
Sub-packaging height	36,00 mm
Sub-packaging width	180,00 mm
Sub-packaging weight	0,63 kg
Sub-packaging volume	0,73 dm <sup>3</sup>
Sub-packaging description	Carton
Sub-packaging quantity	5 Pcs
Sub-packaging EAN barcode	8015747033350

Part number

# CNEM 24 TN



Catalogue drawings

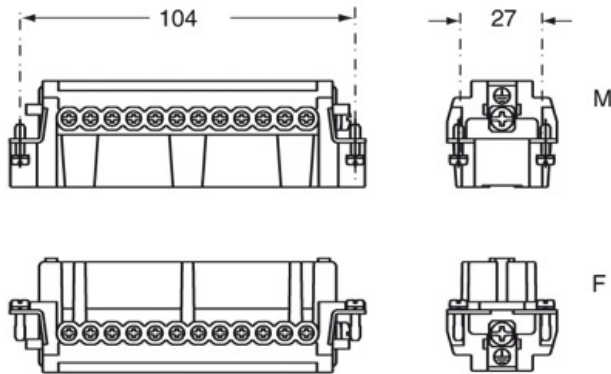

Catalogue drawings

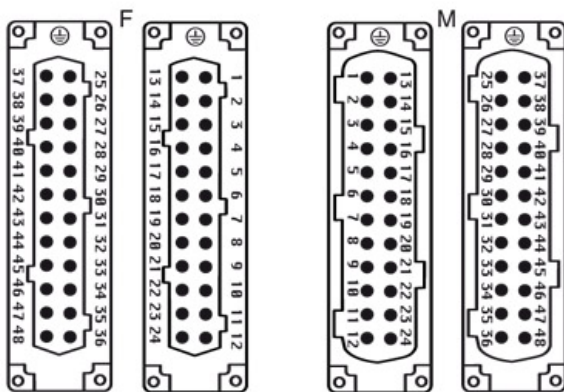
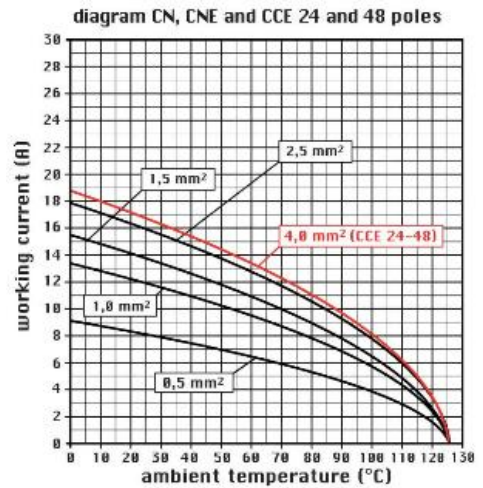

## Notes

CNEF/M 24 TN/TXN inserts:

- characteristics according to EN 61984:  
(16A 500V 6kV 3)  
(16A 400/690V 6kV 2)
- rated voltage according to UL/CSA: 600V
- insulation resistance: > 10 GOhm
- ambient temperature limit: -40 °C ... +125 °C
- are made of self-extinguishing thermoplastic resin UL 94 V0
- mechanical life: > 500 cycles
- contact resistance: < 1 mOhm
- enclosures: size "104.62":

C-TYPE IP65/IP66

W-YPE aggressive environments

CNE ... : for non-prepared conductors

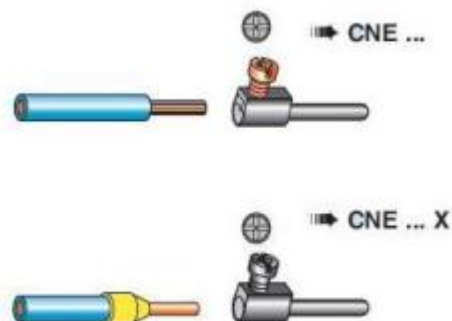

CNE ... X : for conductors with bush terminal

---